



PVI

Prairie View Industries

Quality - Durability - Guaranteed



MODULAR

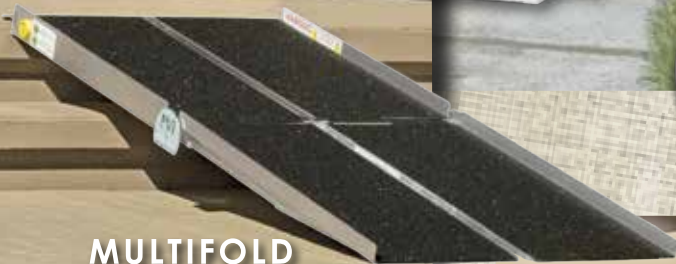

MULTIFOLD



THRESHOLD



SINGLEFOLD

Prairie View Industries, Inc.
www.pviramps.com | 1-800-554-7267

1. **Always** have a qualified assistant present when using any portable ramp.
2. **Never** exceed a slope greater than 2" on 12" with an **occupied** chair or scooter. **Never** exceed a slope greater than 3" on 12" with an **unoccupied** chair or scooter.
3. **Always** make sure that top of ramp is secured on step or landing before using. It may be necessary to anchor top of ramp to landing surface with steel security pins provided.
4. **Make certain** there is adequate head clearance prior to loading an **occupied** chair or scooter into a vehicle.
5. **Always** follow manufacturer recommendations for chair or scooter.
6. **Always** use your lap belt.
7. **Slope Recommendations:**

1:12 SLOPE

1. The ADA recommended slope for long (up to 30') home and commercial ramps.
2. Works for most strong, unassisted manual chair users, although PVI always recommends assistance.

2:12 SLOPE

1. Maximum acceptable grade for portable ramp use by occupied chairs and scooters with a qualified assistant.

3:12 SLOPE

1. For loading **unoccupied** chairs and scooters.

ANY SLOPE GREATER

1. PVI does **NOT** recommend.

8. **Watch** safety DVD prior to use.

To determine the length of ramp for your application, first you will need to determine the rise. The rise is the vertical measurement between the ground and where the top of the ramp is going to sit.

Prairie View Industries recommends NOT to exceed a 2:12 slope on most applications. Some ramps may need to meet ADA (1:12 slope) requirements that are specified by your state. If your rise is over 24", please contact your local dealer about our modular ramp system. To find a 2:12 slope, take total amount of rise and divide by 2. If you have a 12" rise, divide by 2 and the resulting number would be the length of ramp which is required in feet or you would need a 6' ramp. A 1:12 slope would require 1 foot of ramp for every inch of rise.



Note: Consideration must be taken if the ground is not level and slopes away from the rise where ramp will be placed. Please contact your dealer for evaluation on these applications.

QUICK REFERENCE SLOPE GUIDE CHART

Easy as
1-2-3

Step #1 - Measure the rise of your application.

Step #2 - Determine your maximum slope.*

Step #3 - Pick the proper ramp length, based on your selections, in the graph below.

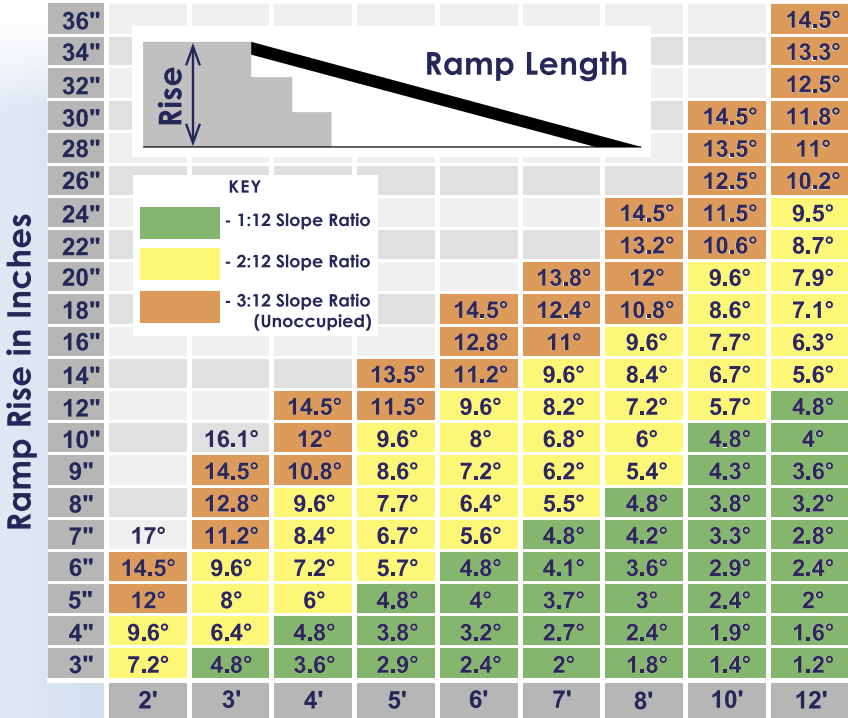

KEY

- 1:12 Slope Ratio
- 2:12 Slope Ratio
- 3:12 Slope Ratio (Unoccupied)

	2'	3'	4'	5'	6'	7'	8'	10'	12'
Singlefold (pg.6)	●	●	●	●	●				
Multifold (pg.4)				●	●	●	●		
Multifold Reach (pg.5)					●	●	●		
Solid (pg.7)		●	●	●					
OnTrac (pg.13)		●	●	●	●	●	●	●	
Elev8 (pg.12)	●	●	●						
Wheel-A-Bout (pg.8)								●	●

*Refer to Slope Recommendations on page to left or visit our website www.pviramps.com/products/calculator to use our ramp length calculator.





- Separates into two pieces for easy carrying
- Rotation of pin either unlocks or locks the ramp sides together without extra tools
- Folds, carries like a suitcase
- Patented hinge eliminates pinch point
- Closure strap locks ramp panels together
- Lightweight, easy-to-handle & set up
- Durable welded construction
- Safety guide indicates if ramp is on a safe slope
- Full platform provides excellent stability and accommodates wheelchairs and scooters with various wheel configurations
- Anti-slip, high traction surface
- Safety DVD and steel security pins included
- Fits in the trunk of most cars for easy transportation



Item Number	Length	Width	Folded Size	Weight	Capacity*
WCR530	5'	30"	32¼" x 16" x 9"	34 lbs.	800 lbs.
WCR630	6'	30"	38¼" x 16" x 9"	40 lbs.	800 lbs.
WCR730	7'	30"	44¼" x 16" x 9"	44 lbs.	800 lbs.
WCR830	8'	30"	50¾" x 16" x 9½"	52 lbs.	800 lbs.
BAR536	5'	36"	32¼" x 17½" x 11½"	50 lbs.	800 lbs.
BAR636	6'	36"	38¼" x 17½" x 11½"	58 lbs.	800 lbs.
BAR736	7'	36"	44¼" x 17½" x 11½"	67 lbs.	800 lbs.
BAR836	8'	36"	50¾" x 17½" x 11½"	76 lbs.	800 lbs.

Not sure which ramp length you need? Refer to pages 2 - 3 to help you.



* Maximum ramp capacity: 400 lbs. (one axle) – 800 lbs. (two axles).





- Extended hook to clear rear bumper
- Red straps included for tailgate usage
- Separates into two pieces for easy carrying
- Rotation of pin either unlocks or locks the ramp sides together without extra tools
- Folds, carries like a suitcase
- Patented hinge eliminates pinch point
- Closure strap locks ramp panels together
- Lightweight, easy-to-handle & set up
- Durable welded construction
- Full platform provides excellent stability
- Anti-slip, high traction surface
- Accommodates wheelchairs and scooters with various wheel configurations
- Safety DVD and steel security pins included
- Fits in the trunk of most cars for easy transportation



See the Difference



Safety Guide Bubble Level

Safety guide indicates if ramp is on a safe slope!

Item Number	Length	Width	Folded Size	Weight	Capacity*
UTW630	6'	30"	38 $\frac{1}{4}$ " x 16" x 10 $\frac{3}{4}$ "	41 lbs.	800 lbs.
UTW730	7'	30"	44 $\frac{1}{4}$ " x 16" x 10 $\frac{3}{4}$ "	46 lbs.	800 lbs.
UTW830	8'	30"	50 $\frac{3}{4}$ " x 16" x 11"	52 lbs.	800 lbs.

Not sure which ramp length you need? Refer to pages 2 - 3 to help you.

* Maximum ramp capacity: 400 lbs. (one axle) – 800 lbs. (two axles).



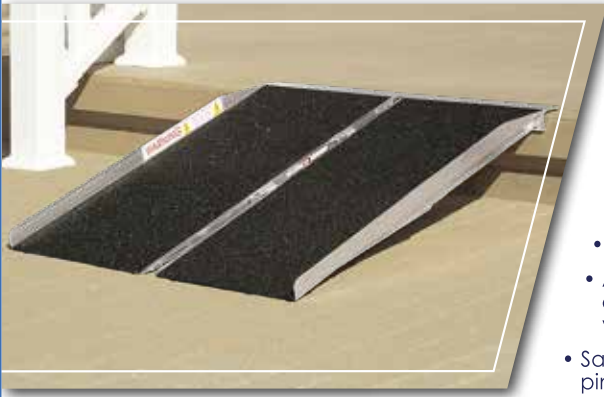

- Lightweight, easy-to-handle and set up
- Folds in half, carries like a suitcase*
- Durable welded construction
- Full platform provides excellent stability
- Anti-slip, high traction surface
- Accommodates wheelchairs and scooters with various wheel configurations
- Safety DVD and steel security pins included
- Fits in the trunk of most cars for easy transportation



Item Number	Length	Width	Folded Size	Weight	Capacity**
SFW230*	2'	30"	24" x 16" x 4 $\frac{7}{8}$ "	10 lbs.	800 lbs.
SFW330	3'	30"	36" x 16" x 4 $\frac{7}{8}$ "	16 lbs.	800 lbs.
SFW430	4'	30"	48" x 16" x 4 $\frac{7}{8}$ "	22 lbs.	800 lbs.
SFW530	5'	30"	60" x 16" x 4 $\frac{7}{8}$ "	28 lbs.	800 lbs.
SFW630	6'	30"	72" x 16" x 4 $\frac{7}{8}$ "	33 lbs.	800 lbs.

Not sure which ramp length you need? Refer to pages 2 - 3 to help you.

*Handle not included on SFW230. ** Maximum ramp capacity: 400 lbs. (one axle) – 800 lbs. (two axles).



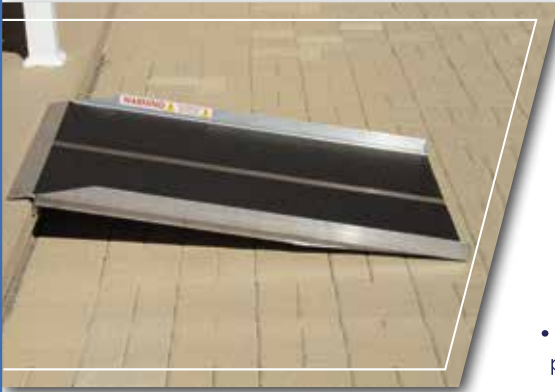

- Full platform provides excellent stability
- Durable welded construction
- Anti-slip, high traction surface
- Accommodates wheelchairs and scooters with various wheel configurations
- Safety DVD and steel security pins included



Custom widths are available. Give your specifications to your local PVI retailer!

Item Number	Length	Width	Weight	Capacity*
SL330	3'	30"	15 lbs.	800 lbs.
SL336	3'	36"	18 lbs.	800 lbs.
SL430	4'	30"	20 lbs.	800 lbs.
SL436	4'	36"	23 lbs.	800 lbs.
SL530	5'	30"	25 lbs.	800 lbs.
SL536	5'	36"	30 lbs.	800 lbs.

Not sure which ramp length you need?
Refer to pages 2 - 3 to help you.

* Maximum ramp capacity: 400 lbs. (one axle) – 800 lbs. (two axles).





- Closure strap locks ramp panels together
- Easy-to-handle & set up
- Durable welded construction
- Full platform provides excellent stability
- Anti-slip, high traction surface
- Accommodates wheelchairs and scooters with various wheel configurations
- Stores upright in garage
- Safety DVD and steel security pins included



Quick Release Pins used to secure Latch Straps

LIMITED LIFETIME WARRANTY

Item Number	Top Hook Length	Length
WAB1030	2 ¾"	10'
WAB1230	2 ¾"	12'
WABU1030	9 ¾"	10'
WABU1230	9 ¾"	12'

Not sure which ramp length you need?

* Maximum ramp capacity:



Stores Upright in Garage



Simply Wheel Out to Required Location

Effortless Wheel Design

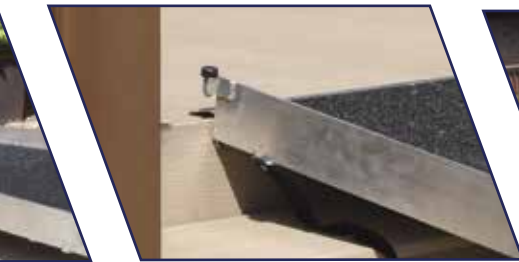

Secure

WAB1030 & WAB1230 Feature
2 3/4" Long Top Hook



Solid / Stable Surface

Width	Folded Size	Weight	Capacity*
30"	66 1/4" x 36 3/4" x 16"	84 lbs.	600 lbs.
30"	78 1/4" x 36 3/4" x 16"	98 lbs.	600 lbs.
30"	63 1/4" x 36 3/4" x 16"	83 lbs.	600 lbs.
30"	75 1/4" x 36 3/4" x 16"	97 lbs.	600 lbs.

Need? Refer to pages 2 - 3 to help you.

300 lbs. (one axle) – 600 lbs. (two axles).



RUBBER & PLASTIC THRESHOLD



- No load weight limitations
- Molded miter ends
- Made of recycled material
- Designed and tested for maximum slip resistance
- Field fitted with simple cutting tools
- Simple installation in 15 to 25 mins.
- No fasteners required for installation
- Foot traffic is quiet and solid
- Comes with Limited Lifetime Warranty



Coated Color Options.*
Please check for availability.

Item Number	Material	Length	Width	Usable Width	Height	Weight
RAEZ0010**	Rubber	3¼"	41½"	32"	½"	3 lbs.
RAEZ0110**	Rubber	8"	41½"	32"	1"	8 lbs.
RAEZ1110**	Rubber	14"	46"	36"	1⅜"	20 lbs.
RAEZ1510**	Rubber	22"	46"	36"	1⅝"	40 lbs.
RAEZ2100**	Rubber	24"	60"	50"	2"	62 lbs.
STC0110*	Coated Rubber	8⅞"	42"	32"	1"	8 lbs.
STC1110*	Coated Rubber	14"	46"	36"	1⅜"	20 lbs.
STC1510*	Coated Rubber	22"	46"	36"	1⅝"	40 lbs.
BHR1110*	Coated Plastic	12"	42¾"	36"	1¼"	12 lbs.

*Colors vary slightly due to printing. Coating may fade or discolor over time.

**RAEZ models only available in black.





- Designed for doorways that swing in
- Holes punched in top corners for easy installation
- Lightweight, durable aluminum
- Anti-slip, high traction surface
- Hardware provided to secure ramp to surface

Item Number	Length	Width	Threshold Height	Weight	Capacity*
THR832	8"	32"	¼" - ½"	3 lbs.	600 lbs.
TH1032	10"	32"	½" - ¾"	4 lbs.	600 lbs.
TH1232	12"	32"	¾" - 1½"	5 lbs.	600 lbs.
TH1632	16"	32"	1½" - 2"	6 lbs.	600 lbs.
TH1636	16"	36"	1½" - 2"	6 lbs.	600 lbs.
TH2432	24"	32"	2" - 4"	12 lbs.	600 lbs.
TH2436	24"	36"	2" - 4"	15 lbs.	600 lbs.
BAR1636	16"	36"	1½" - 2"	12 lbs.	800 lbs.
BAR2436	24"	36"	2" - 4"	21 lbs.	800 lbs.

* Maximum ramp capacity: 300 lbs. (one axle) – 600 lbs. (two axles).

SELF SUPPORTING THRESHOLD



- Designed for doorways that swing in or out
- Durable welded construction
- Anti-slip, high traction surface
- Accommodates wheelchairs and scooters with various wheel configurations
- Aligns directly against the door threshold

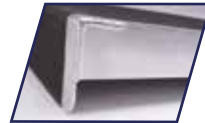

Item Number	Length	Width	Threshold Height	Weight	Capacity*
SSTH2436-3	24"	36"	3"	12 lbs.	600 lbs.

* Maximum ramp capacity: 300 lbs. (one axle) – 600 lbs. (two axles).



- Designed for doorways that swing in or out
- Adjustable to fit range of threshold rises
- Durable welded construction
- Slip resistant grooved aluminum
- Accommodates wheelchairs and scooters with various wheel configurations
- Aligns directly against the door threshold
- Anchoring hardware included

The Ramp with Adjustable Heights



Item Number	Length	Width	Threshold Height	Weight	Capacity*
ATH1232	12"	32"	1 3/8" - 2"	6 lbs.	800 lbs.
ATH1236	12"	36"	1 3/8" - 2"	8 lbs.	800 lbs.
ATH2432	24"	32"	2 3/8" - 3 1/2"	12 lbs.	800 lbs.
ATH2436	24"	36"	2 3/8" - 3 1/2"	14 lbs.	800 lbs.
ATH3632	36"	32"	3" - 6"	19 lbs.	800 lbs.
ATH3636	36"	36"	3" - 6"	21 lbs.	800 lbs.
ATH4832	48"	32"	4" - 6"	26 lbs.	800 lbs.
ATH4836	48"	36"	4" - 6"	28 lbs.	800 lbs.

* Maximum ramp capacity: 400 lbs. (one axle) – 800 lbs. (two axles).





- Ramps available in lengths of 3', 4', 5', 6', 7', 8', 9' and 10'
- Comes with handrail
- Welded in 3', 4' or 5' sections and then spliced to create additional sizes
- Installs in minutes
- Durable and weather resistant
- Slip resistant grooved aluminum surface
- All aluminum construction
- Little or no maintenance
- ADA extended handrail available upon request



Item Number	Length	Width	Weight	Capacity*
XPS336	3'	36"	49 lbs.	850 lbs.
XPS436	4'	36"	59 lbs.	850 lbs.
XPS536	5'	36"	69 lbs.	850 lbs.
XPS636	6'	36"	88 lbs.	850 lbs.
XPS736	7'	36"	98 lbs.	850 lbs.
XPS836	8'	36"	108 lbs.	850 lbs.
XPS936	9'	36"	117 lbs.	850 lbs.
XPS1036	10'	36"	127 lbs.	850 lbs.

Not sure which ramp length you need?
Refer to pages 2 - 3 to help you.



* Maximum ramp capacity:
425 lbs. (one axle) – 850 lbs. (two axles).





- Ramp sections welded in lengths of 3', 4' & 5'
- Can be easily moved or reconfigured
- Durable and weather resistant
- Little or no site preparation required
- All aluminum construction
- Little or no maintenance
- 45° and 90° turns and switchbacks
- Multiple configurations possible
- ADA handrail extensions, stairs and gates available
- Accommodates a rise up to 60"
- Comes with a Limited Lifetime Warranty



Multiple configurations possible!

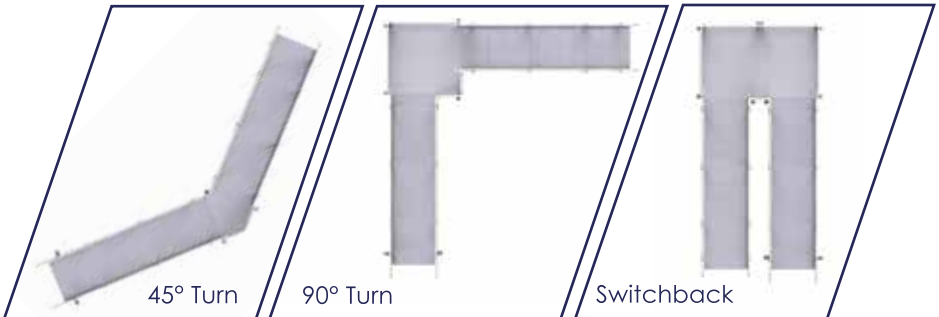



LIMITED **LIFETIME** WARRANTY

Width	36"
Length	As Required - 4' minimum
Load Capacity	100 lbs. per square foot
Slope	Adjustable - as required
Floor	Slip resistant grooved aluminum
Ramp Edge Protection	4" Curb
Handrails	Double 1½" bar - standard height 36"





With superior quality
ramps we've been
breaking down
barriers since 1991.

Our products are
made in the U.S. and
we guarantee our
access ramps will last
a lifetime.*

Contact Your Local Dealer Today!

Prairie View Industries, Inc. | Fairbury, NE
(800) 554.7267 | www.pviramps.com

*PVI access ramps come with a *Limited Lifetime Warranty*.